

An energy-saving solenoid latch that requires no power to remain open or closed.



NEW

Solenoid Latch (Self Holding)

1

The latch retracts when energized for 0.1 second

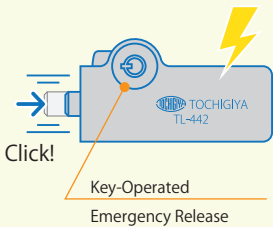

For Door

Release

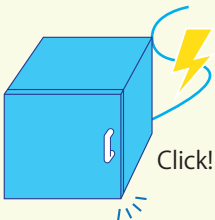

For Drawer

Release

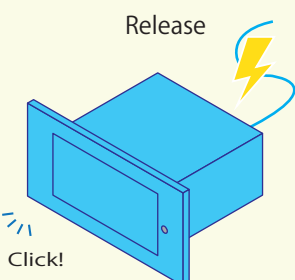

2

The latch stays in the retracted position even without power.



Free Opening and Closing

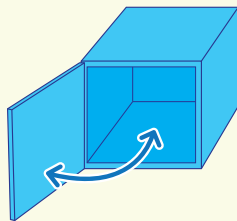

Free Opening and Closing

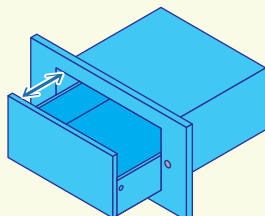

3

The latch extends with 0.1 seconds of reverse-polarity power.

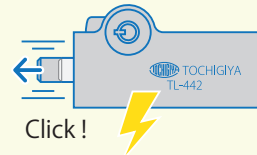

Lock

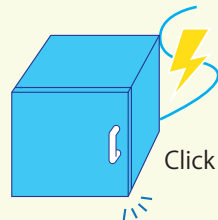

Lock

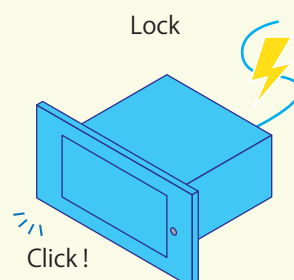

4

The latch remains extended even when power is off.

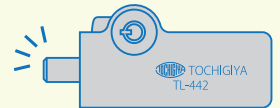

Will Not Open Until Powered

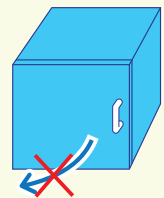

Will Not Open Until Powered

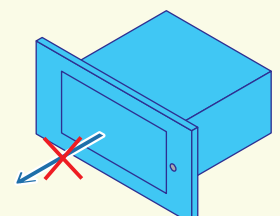

TL-442



Solenoid Latch (Self Holding)

Specification



型番	自重 (g)	
TL-442-1-6V	173	
TL-442-1-12V	173	
TL-442-1-24V	173	

Dimensions in MM

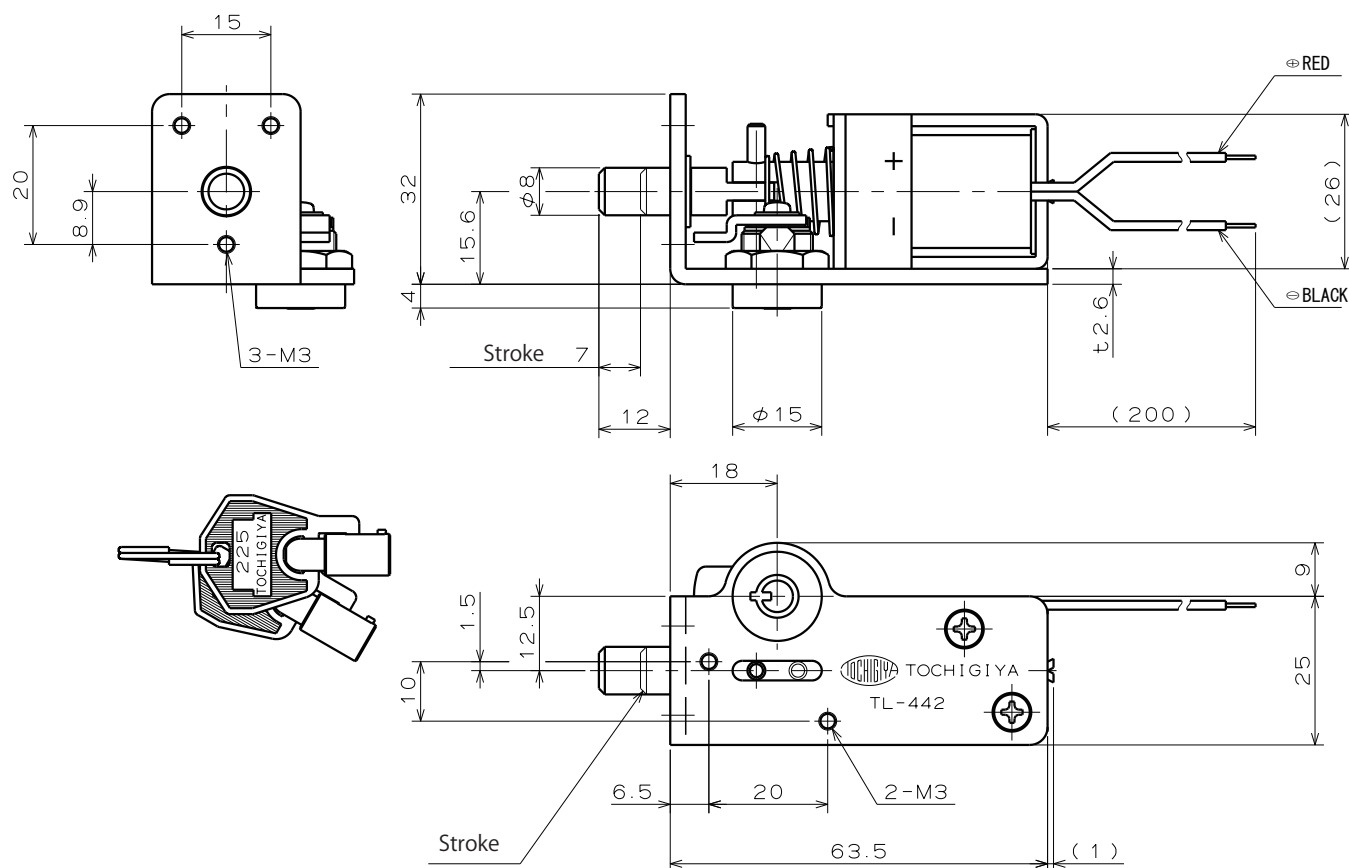

Custom lengths and colors are available. Please feel free to contact us.

TOCHIGIYA TOCHIGIYA CO.,LTD.
<https://tochigiya.jp/shop/>



TOCHIGIYA ONLINESHOP

search