

TEM-1011 / TEM-1038 ガスケット

Gasketing



特長

内部の芯金により差し込むだけで取り付けられるガスケットです。様々な形状がございます。芯金なしタイプもございます。

用途

ラック・筐体等

仕様

使用温度範囲：-40℃～+100℃

Characteristic

The internal steel spring core can make it easy to install the gasketing by only pushing. Appropriate size can be selected for various devices. Also have gasketing without steel spring core.

Application

Rack / Box, etc.

Specification

Operating Temperature Range: -40℃～+100℃

最小曲げ半径説明図
Minimum Bending Radius

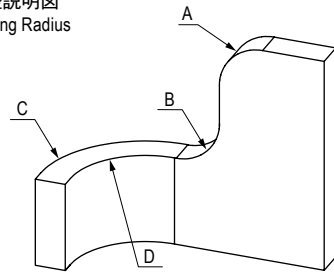

使用例
Application Example

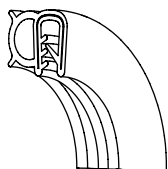
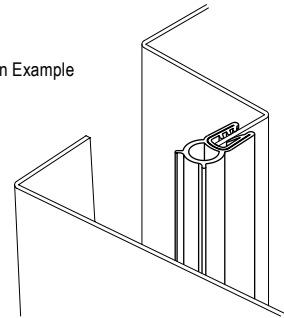

上記方向に曲げた場合…A
Above figure shows bending direction…A

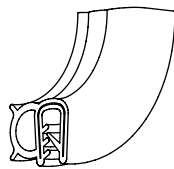

上記方向に曲げた場合…B
Above figure shows bending direction…B

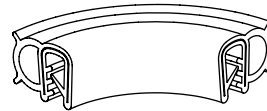

上記方向に曲げた場合…C
Above figure shows bending direction…C

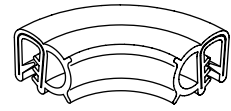

上記方向に曲げた場合…D
Above figure shows bending direction…D

寸法・仕様表 Size List & Specification ※長さについてはご指定ください。 Please specify the length when ordering.

型番 Model No.	適用板厚 Applicable Plate Thickness	最小曲げ半径 Minimum Bending radius				自重 (g) Net Weight (g)
		A	B	C	D	
TEM-1011-05	t1 ~ t3.5	R50	R90	R30	R30	147
TEM-1011-06			R40	R80	R100	118
TEM-1011-08	t0.8 ~ t2.5	R200	R50	R100	R200	154
TEM-1011-09		R40	R30	R40	R80	113
TEM-1011-10			R80	R20	R20	123
TEM-1011-12		R50	R40	R50	R200	149
TEM-1011-32	t1 ~ t3	R80	R250	R25	R60	174
TEM-1011-34		R160		R200	R200	184
TEM-1011-36		R150	—	R15	R15	180
TEM-1011-37		R50		R70	R40	160
TEM-1011-40	t1 ~ t4	R55	R18	R250	R150	190
TEM-1011-44	t0.5 ~ t2	R60	R100	R180	R200	132
TEM-1011-45	t3 ~ t5	R70	R20	R120	R100	240
TEM-1038-02	t1 ~ t1.6	R90	R50	R20	R20	73
TEM-1038-06	t1.5 ~ t2	R80	R30	R10	R10	33

■部品表 Parts List

部番 No.	部品名 Part Name	材質 Material	処理 Finish	数 Quantity
1	ガスケット Gasket	EPDM	黒色 Black	1
2	芯金 Core	S	—	1
3	スポンジゴム Sponge Rubber	EPDM	黒色 Black	1

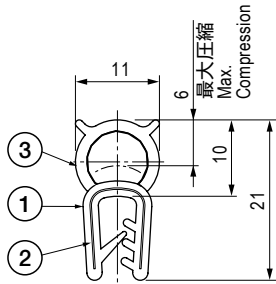

TEM-1011-05

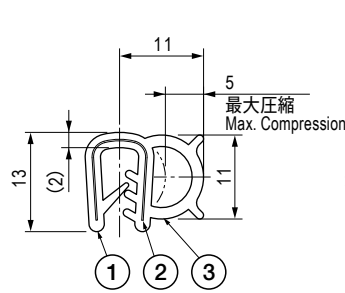

TEM-1011-06

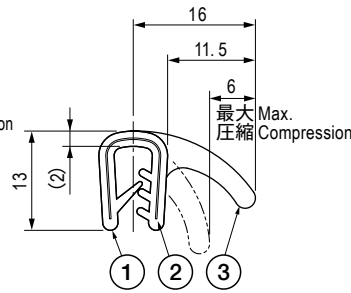

TEM-1011-08

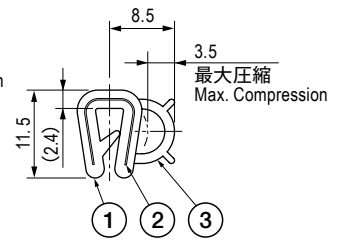

TEM-1011-09

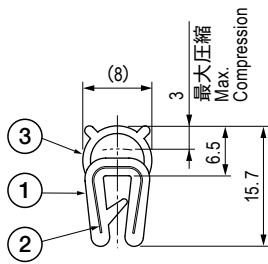

TEM-1011-10

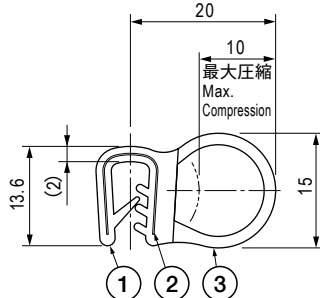

TEM-1011-12

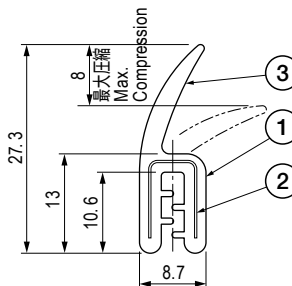

TEM-1011-32

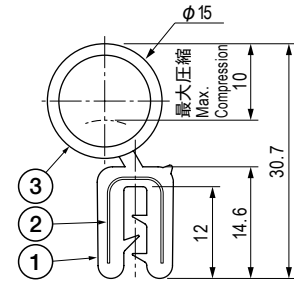

TEM-1011-34

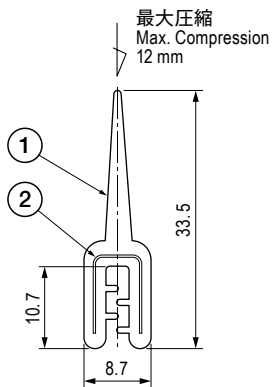

TEM-1011-36

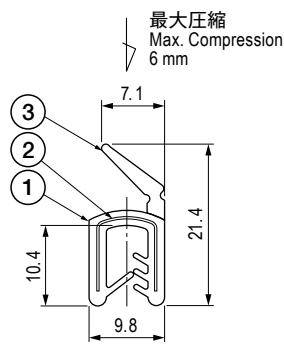

TEM-1011-37

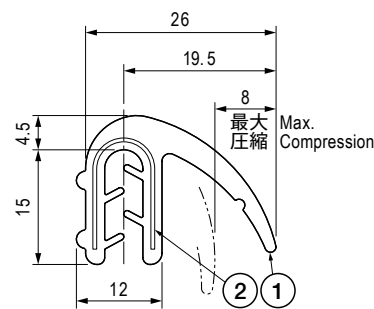

TEM-1011-40

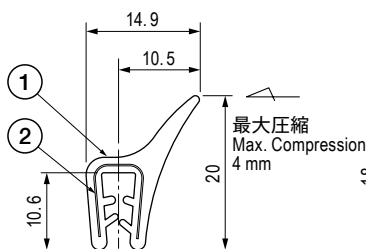

TEM-1011-44

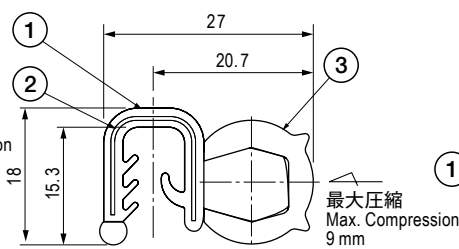

TEM-1011-45

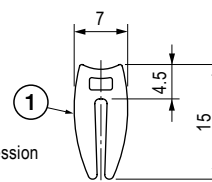

TEM-1038-02

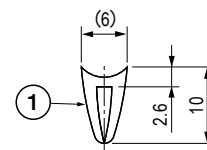

TEM-1038-06

クォーターターン
Quarter Turns
スウィングハンドル
Swing Handles

ヒンジ
Hinges

ガスケット
Gaskets